

## LG-NMT1312 (TOP BEND)

- Adopt eco-friendly silicone of high light transmission and integrated extrusion molding process, featured in IP67 protection.
- Proved to be resistant to hydrochloric, acid and alkali corrosion, flame retardant, UV yellowing through 9 tests.
- Systematic installation solution for different installation requirements.
- Embrace boundless potential. Can achieve various creative styles to meet diverse needs of application scenarios.

620lm/710lm  
740lm/690lm  
650lm  
LUMENS

9.6W/M  
12W/M  
TYPICAL WATT

2200K/2700K  
3000K/4000K  
CCT  
COLOUR

IP67  
IP RATING

24V  
DC

115°  
BEAM ANGLE

3  
YEARS  
WARRANTY

OPTIONAL  
DIMMING

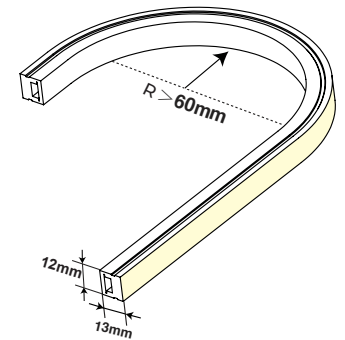
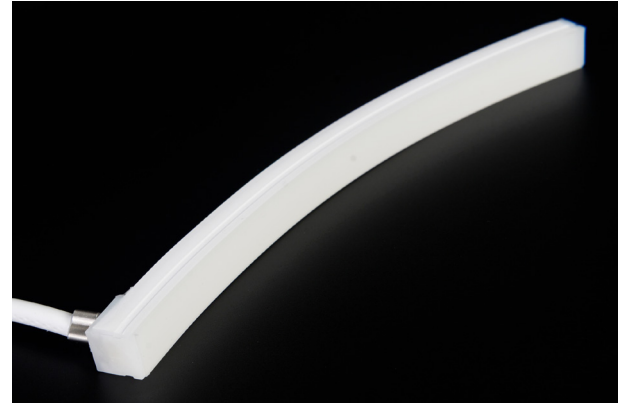

### Accessories

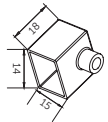

**End Cap Set**  
LG-AS-NMT1312GSO-EC  
(L14 x W15 x H18mm)

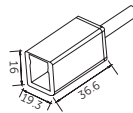

**Top Connector**  
LG-AS-NMT1312HT0-FL  
(Wire: 500mm/ IP54)

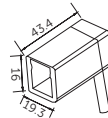

**Bottom Connector**  
LG-AS-NMT1312HB0-FL  
(Wire: 500mm/ IP54)

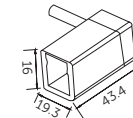

**Left Connector**  
LG-AS-NMT1312HL0-FL  
(Wire: 500mm/ IP54)

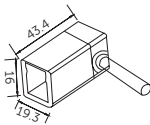

**Right Connector**  
LG-AS-NMT1312HR0-FL  
(Wire: 500mm/ IP54)

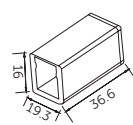

**Quick Connector EC**  
LG-AS-NMT1312TX0-FL  
(IP54)

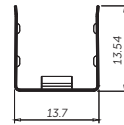

**Moldable Groove**  
LG-AS-NMT1312M-500  
(L500 x W13.7 x H13.54mm)

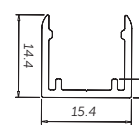

**Flat Al Carrier / Clip**  
LG-AS-NMT1312A-1000/25  
(L1000/25 x W15.4 x H14.4mm)

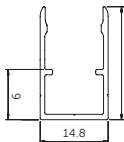

**Reserved Al Carrier / Clip**  
LG-AS-NMT1312A1-1000/25  
(L1000/25 x W14.8 x H20mm)

IK08

SALTWATER RESISTANT

SOLVENT RESISTANT

UV RESISTANT

CE

UL  
E498657

ROHS

Reach

CB

UK CA

Model	IP Rating	Typical Power (W/M)	Max Power (W/M)	Lumen Output (lm)	CCT	CRI	Beam Angle	Dimming	Cutttable (mm)	Dimensions	Voltage	Bend Radius
LG-NMT1312	IP67	9.6W/M	10.6W/M	620lm/M 710lm/M 740lm/M 690lm/M	2200K 2700K 3000K 4000K	≥90	115°	Optional	7LED 50mm	13x12mm	24V DC	≥60 mm
		12W/M	14W/M	650lm/M	CCT* (2700K-5000K)				31.25mm			

\* Specified Stock